



8 1/4" ETA 256.041

CT 256041 ESI 487540 03 17.06.2009

8 1/4" Ø 18,20 mm

 <p>LONG LIFE</p>			
Movement height	Altura sobre máquina	Altezza sopra movimento	1,95 mm
Height on battery	Altura sobre pila	Altezza sopra pila	2,10 mm
Number of jewels	Número de piedras	Numero di pietre	6
Frequency	Frecuencia	Frequenza	32'768 Hz

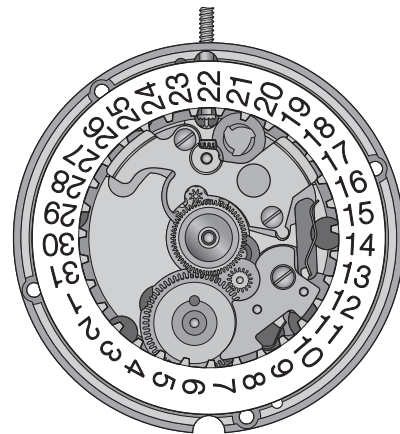

The repair and reconditioning work must only be performed by properly trained personnel.
 Las tareas de reparación y revisión sólo deben ser llevadas a cabo por personal debidamente formado.
 I lavori di riparazione e di revisione devono essere eseguiti esclusivamente da personale adeguatamente formato.



List of components - Lista de piezas - Lista fornitori

Pos	No	No CS	Article number Número de artículo Numero articolo	List of components	Lista de piezas	Lista fornitori
-	100	10.020.07	-	Main plate, jewelled	Platina, empedrada	Piastra con pietre
-	110	10.048.07	-	Train wheel bridge, jewelled	Puente de rodaje, empedrado	Ponte del ruotismo con pietre
-	144	10.300.00	-	Dial fastener	Fijador de esfera	Ferma-quadrante
-	161	80.400.00	-	Centre tube	Tubito de centro	Tubo di centro
-	203	30.012.00	-	Intermediate wheel	Rueda intermedia	Ruota intermedia
-	210	30.025.00	-	Third wheel	Rueda primera	Ruota mediana
-	242/1	31.083.18	-	Cannon pinion with driving wheel, without sweep second	Cañón de minutos con arrastrador, sin segundero en el centro	Pignone calzante con conduttore, senza secondo al centro
-	255/1	31.046.06	-	Hour wheel, assembled	Rueda de horas, montada	Ruota delle ore, montata
-	260	31.041.00	-	Minute wheel	Rueda de minutería	Ruota della minutería
-	405	51.020.21	-	Handsetting stem, thread diameter 0.90 mm	Tija de puesta en hora, diámetro fileteado 0,90 mm	Albero di messa all'ora, diametro filettatura, 0,90 mm
-	407	31.121.00	-	Sliding pinion	Piñón corredizo	Pignone scorrevole
-	435/1	51.050.06	-	Yoke, assembled	Báscula de piñón corredizo, montada	Bascula del pignone scorrevole, montata
-	443/1	51.080.06	-	Setting lever, assembled	Tirete montado	Tiretto montato
-	445	51.090.00	-	Setting lever jumper	Muelle flexible de tirete	Scatto del tiretto
-	450	31.100.00	-	Setting wheel	Rueda de transmisión	Rinvio
-	462	10.062.00	-	Minute train bridge	Puente de redaje de minutería	Ponte del ruotismo di minutería
-	482	61.092.00	-	Setting lever recall spring	Muelle de retorno de tirete	Molla di richiamo del tiretto
-	491	51.081.00	-	Lever for setting lever	Palanquita de tirete	Leva del tiretto
-	560	56.071.00	-	Stop lever and switch	Palanquita de parada e interruptor	Leva di arresto e interruttore
-	2543	33.011.00	-	Intermediate date wheel	Rueda intermedia de fecha	Ruota intermedia del datario
-	2556	33.020.00	-	Date indicator driving wheel	Rueda de arrastre del indicador de fecha	Ruota conduttrice dell'indicatore della data
-	2557/1	91.440.22	-	Date indicator, for opening at 3 o'clock	Indicador de fecha, abertura de ventanilla en las 3 h	Indicatore della data, apertura dello sportellino sulle ore 3
-	2576	53.080.00	-	Date jumper	Muelle flexible de fecha	Scatta-data
-	2595	13.111.00	-	Date jumper maintaining plate	Placa de sujeción del muelle flexible de fecha	Placca di guardia dello scatta-data
-	4000	10.513.00	-	Electronic module	Módulo electrónico	Modulo elettronico
-	4021	20.582.00	-	Stator	Estátor	Statore
-	4041	20.586.00	-	Magnetic screen, lateral	Pantalla magnética, lateral	Schermo magnetico, laterale
-	4046	20.651.00	-	Battery insulator	Aislador de pila	Isolatore della pila
-	4211	20.580.00	-	Rotor	Rotor	Rotore
-	4401	20.761.00	-	Bridle +	Brida +	Brida +
-	4412	10.601.00	-	Battery limiting spring	Muelle de limitación de pila	Molla di limitazione della pila
-	4929	20.570.00	-	Battery	Pila	Pila
1)	5110	10.048.01	-	2x Screw for train wheel bridge	Tornillo de puente de rodaje	Vite del ponte del ruotismo
1)	5445	51.090.01	-	1x Screw for setting lever jumper	Tornillo del muelle flexible de tirete	Vite dello scatto del tiretto
2)	5462	10.062.01	-	2x Screw for minute train bridge	Tornillo de puente de rodaje de minutería	Vite del ponte del ruotismo di minutería
1)	5482	61.092.01	-	1x Screw for setting lever recall spring	Tornillo de muelle de retorno de tirete	Vite della molla di richiamo del tiretto
2)	52595	13.111.01	-	1x Screw for date jumper maintaining plate	Tornillo de placa de sujeción del muelle flexible de fecha	Vite della placca di guardia dello scatta-data
-	54000	10.513.01	-	4x Screw for electronic module	Tornillo de módulo electrónico	Vite del modulo elettronico
1)	54041	20.586.01	-	1x Screw for lateral magnetic screen	Tornillo de pantalla magnética, lateral	Vite dello schermo magnetico, laterale
1)	54401	20.761.01	-	1x Screw for bridle +	Tornillo de brida +	Vite di contatto +
				Identical screws Tornillos idénticos Viti identiche	1) 5110 5445 5482 54041 54401	2) 5462 52595
			Var	Variante	Variante	Variant

Interchangeability and variants can be found on the **ETA ONLINE SHOP (EOS):**

www.eta.ch

- Customer Service
- Customer Service Portal

La intercambiabilidad y las variantes se encuentran en **ETA ONLINE SHOP (EOS):**

www.eta.ch





























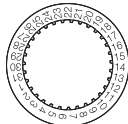

- Customer Service
- Customer Service Portal

L'intercambiabilità e le varianti si trovano sul **ETA ONLINE SHOP (EOS):**

www.eta.ch

- Customer Service
- Customer Service Portal

Materials - Fornituras - Forniture

								<p>▼</p> <p>5110 5445 5482 54041 54401</p>
100	110	144	161	203	210	242	255/1	
								
260	405	407	435/1	443/1	445	450	462	
								<p>▼</p> <p>5462 52595</p>
482	491	560	2543	2556	2557/1	2576	2595	
								<p>▼</p> <p>54000</p>
4000	4021	4041	4046	4211	4401	4412	4929	

Assembling of the calendar mechanism

(Parts listed in order of assembly)

Montaje del mecanismo de calendario

(Lista de fornitureas por orden de ensamblado)

Montaggio del meccanismo di calendario

(Elenco delle forniture in ordine di montaggio)

100	450	462
242/1	2576	5462 (2x)
2556	2595	255/1
2543	52595 (1x)	
260	2557/1	

M_L Minimum torque for loosening

M_L Par mínimo para desatornillar

M_L Coppia minima per svitare

(a) 0,6 Ncm

Lubrication - Lubricación - Lubrificazione

 Fine oil
Aceite fino
Olio fluido

Moebius 9014
or / ó / o
Moebius 9034

 Thick, pressure-resistant oil or grease
Aceite espeso de viscosidad elevada o grasa
Olio denso a viscosità elevata o grasso

Moebius HP-1300
or / ó / o
Moebius D5

 Grease
Grasa
Grasso

Moebius 9501
or / ó / o
Jismaa 124

 Very small quantity
Cantidad muy pequeña
Piccolissima quantità

Moebius HP-1300
or / ó / o
Moebius D5

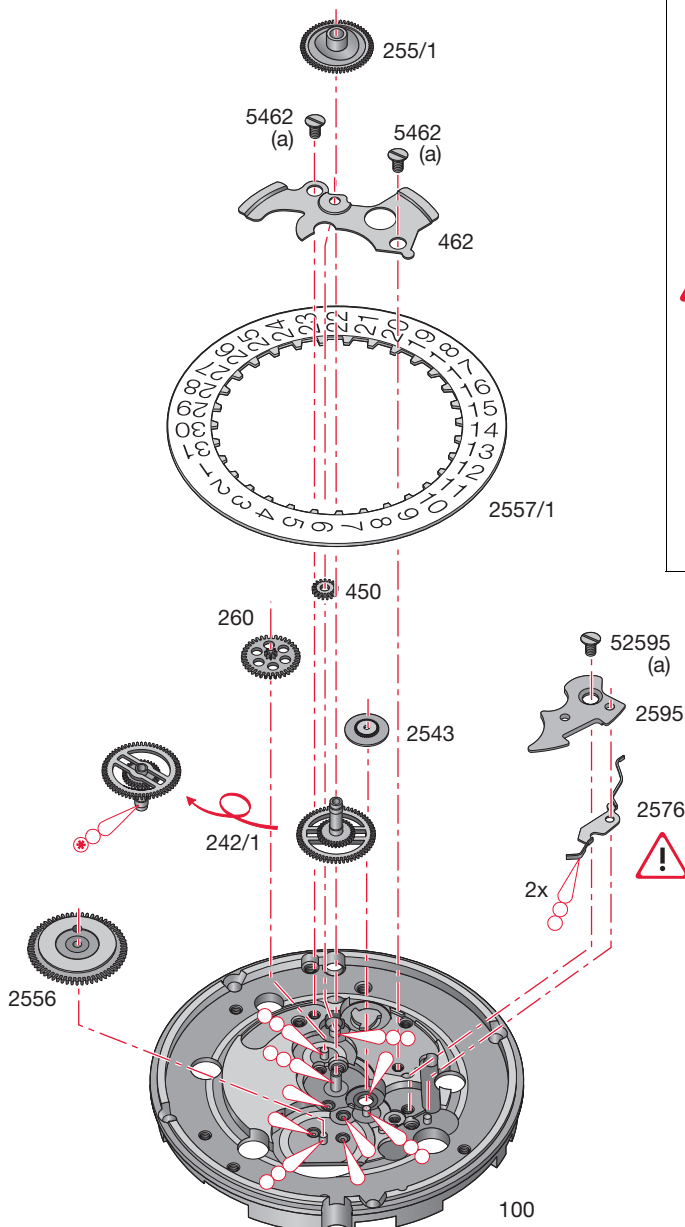

Lubricate part 2576.

1. Lubrique la pieza 2576.
Lubrificare il pezzo 2576.

Rotate part 2557/1 approx 10 teeth with rapide correction.

2. Gire la pieza 2557/1 unos 10 dientes con la corrección rápida.
Ruotare il pezzo 2557/1 di circa 10 denti con la correzione rapida.

Lubricate again part 2576.

3. Lubrique de nuevo la pieza 2576.
Lubrificare di nuovo il pezzo 2576.

Rotate part 2557/1 approx 10 teeth with rapide correction again.

4. Gire de nuevo la pieza 2557/1 unos 10 dientes con la corrección rápida.
Ruotare di nuovo il pezzo 2557/1 di circa 10 denti con la correzione rapida.

Lubrication - Lubricación - Lubrificazione

 Fine oil
Aceite fino
Olio fluido

Moebius 9014
or / ó / o
Moebius 9034

 Thick, pressure-resistant oil or grease
Aceite espeso de viscosidad elevada o grasa
Olio denso a viscosità elevata o grasso

Moebius HP-1300
or / ó / o
Moebius D5

 Grease
Grasa
Grasso

Moebius 9501
or / ó / o
Jismaa 124

Assembling of the date and corrector mechanism

(Parts listed in order of assembly)

Montaje del mecanismo de fecha y de corrector

(Lista de fornitureas por orden de ensamblado)

Montaggio del meccanismo della data e del correttore

(Elenco delle forniture in ordine di montaggio)

407	482	4041
405	5482 (1x)	54041 (1x)
491	4021	4401
443/1	4211	54401 (1x)
560	210	4046
435/1	203	4000
445	110	54000 (3x)
5445 (1x)	5110 (2x)	4929

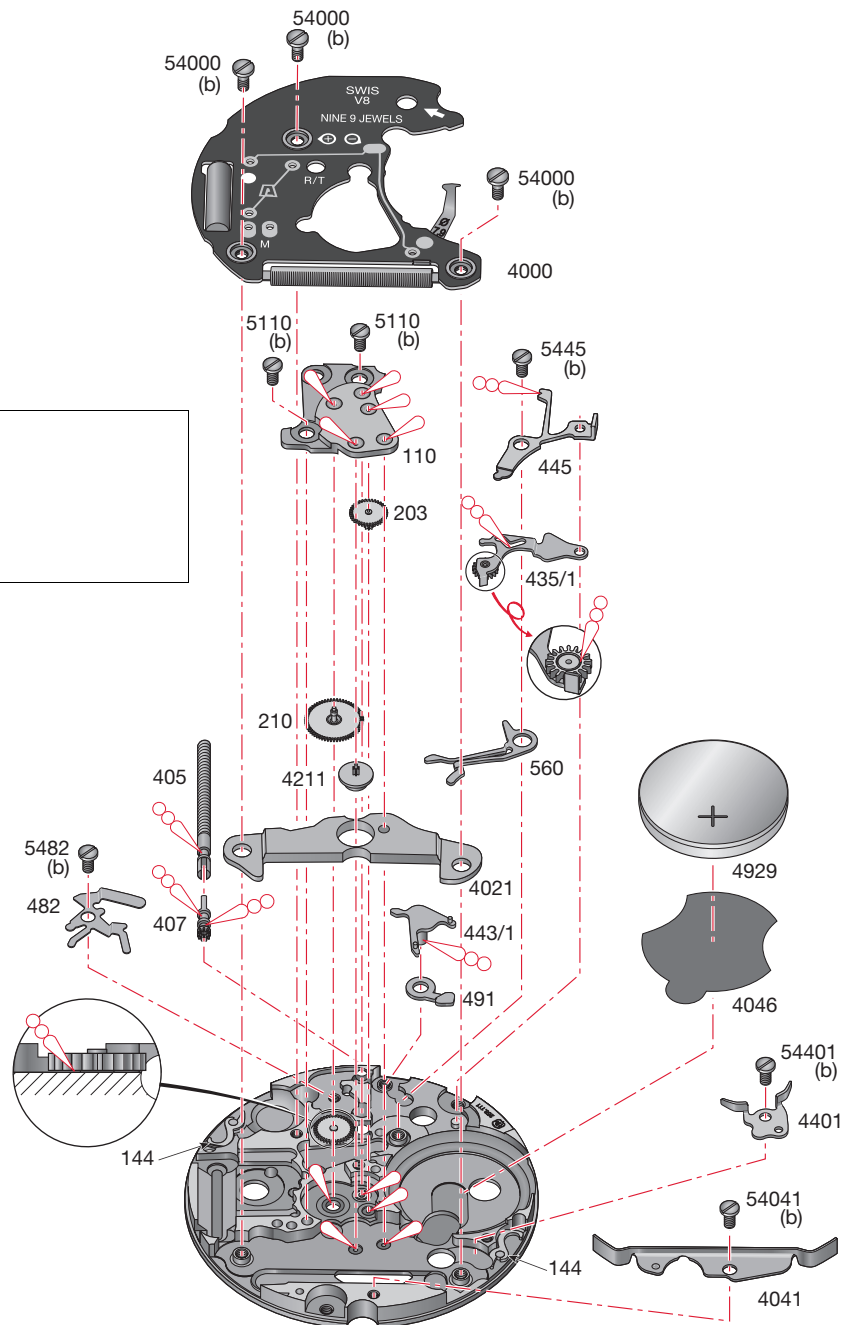

M_L Minimum torque for loosening

M_L Par mínimo para desatornillar

M_L Coppia minima per svitare

(b) 0,7 Ncm

Electrical tests - Controles eléctricos - Controlli elettrici

Position Posición Posizione	Setting of apparatus Escala de medición Scala di misura	Measurement Medición Misura	Test Control Controllo	Remarks Notas Osservazioni
1	2 V ($R_i \geq 10 \text{ k}\Omega/\text{V}$)	1,55 V	Battery voltage. Tensión de la pila. Tensione della pila.	Measurement with battery. Medición con una pila. Misura con una pila.
2	1 V ($R_i \geq 10 \text{ k}\Omega/\text{V}$)	Hand of measuring apparatus oscillates in + and - direction. La aguja del multímetro oscila en sentido + y -. La lancetta del mutlimetro oscilla nel senso + e -.	Impulses at output of integrated circuit. Impulsos a la salida del circuito integrado. Impulsi all'uscita del circuito integrato. 12 / min	Measurement with controlled battery. Medición con una pila controlada. Misura con una pila controllata.
3	2 V	$\leq 1,30 \text{ V}$ Connect R/T point with the - conductor. Motor driven with 32 steps/s or 16 steps/s. Connectar el punto R/T con la pista -. Mando del motor con 32 pasos/s o 16 pasos/s. Mettere in contatto il punto R/T con la pista -. Comando del motore con 32 passi/s o 16 passi/s.	Lower working voltage limit. Límite inferior de la tensión de funcionamiento. Limite inferiore della tension di funzionamento.	Measurement without battery, with variable external power supply, starting with 1.55 V, lower tension until movement stops. Medición sin pila, con alimentación exterior variable bajando de 1,55 V hasta la parada de la máquina. Misura senza pila con alimentazione esterna variabile, scendendo da 1,55 V fino all'arresto del movimento.
		$\leq 0,75 \mu\text{A}$	Power consumption of movement. Consumo de la máquina. Consumo del movimento.	Measurement without battery, with power-supply unit 1.55 V. Medición sin pila, con alimentación exterior de 1,55 V. Misura senza pila con alimentazione esterna di 1,55 V.
	10 μA	EOL. Consumption higher than in normal operation. EOL. Consumo superior al valor normal. EOL. Consumo superiore al valore normale.	EOL. Consumption higher than in normal operation. EOL. Consumo superior al valor normal. EOL. Consumo superiore al valore normale.	Measurement without battery, with supply voltage < 1.30 V, EOL-Function after about 2 minutes. Medición sin pila, con tensión de alimentación < 1,30 V, EOL-funcionamiento después de ~ 2 minutos. Misura senza pila, con tensione di alimentazione < 1,30 V EOL funzionamento dopo 2 minuti.
		< 0,40 μA	Function of stop lever, pos. 3 of hand-setting stem. Funcionamiento del interruptor en pos. 3 de la tija de puesta en hora. Funzionamento dell'interruttore in posizione 3 dell'albero di messa all'ora.	Measurement without battery, with power-supply unit 1.55 V. Medición sin pila, con alimentación exterior de 1,55 V. Misura senza pila con alimentazione esterna di 1,55 V.
4	• 10 k Ω 200 μA	1,30–1,60 k Ω 125–155 μA	Condition of coil. Continuidad de la bobina. Continuità della bobinatura.	
<p>Ohmmeter with a test voltage higher than 0.40 V unsuitable, recommended voltage 0.20 V. • Ohmiómetros con tensión de medición superior a 0,4 V inapropiados, tensión recomendada 0,20 V. Ohmmetri con tensione di misura superiore a 0,4 V inappropriati, tensione raccomandata 0,20 V.</p>				

The test must be conducted at an ambient temperature of between 20°C and 25°C.
 Las pruebas deben realizarse a una temperatura ambiente comprendida entre 20°C y 25°C.
 I test devono essere effettuati a temperatura ambiente compresa tra 20°C e 25°C.

Electrical tests - Controles eléctricos - Controlli elettrici

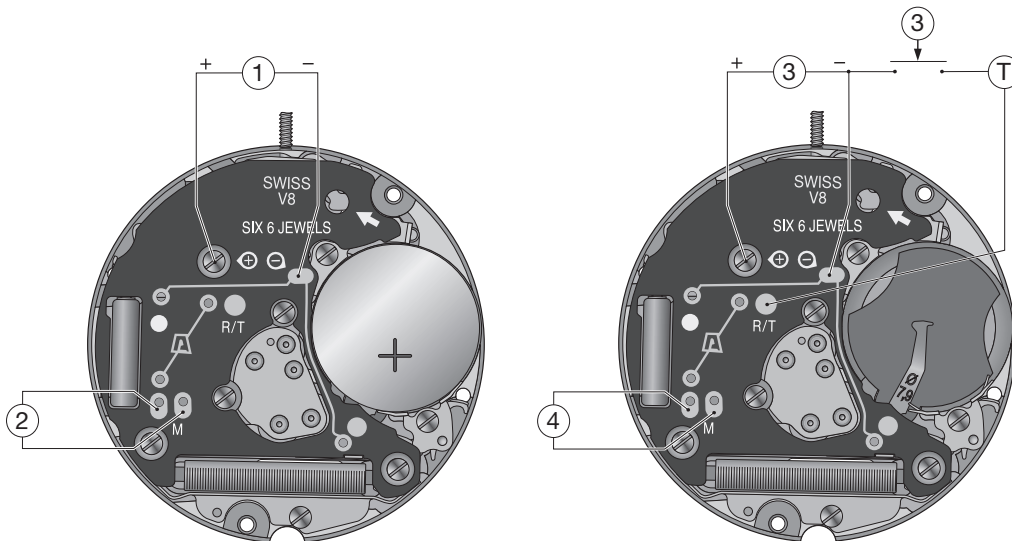

Extracting the stem

To extract the stem, press the lever for setting lever, shown by an arrow, with a screwdriver 1.00 mm in diameter.

Extacción de la tija de puesta en hora

Sacar la tija de puesta en hora apretando la palanquita de tirete, indicado por una flecha, con un destornillador con un de Ø 1,00 mm.

Estrazione dell'albero di messa all'ora

Estrarre l'albero di messa all'ora premendo sulla leva del tiretto, segnato con una freccia, con un cacciavite Ø 1,00 mm.

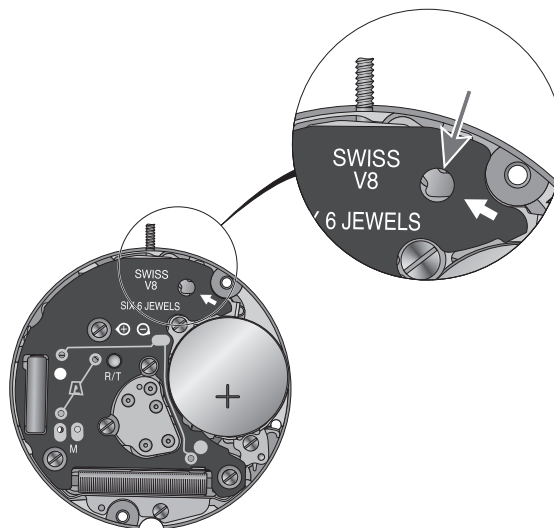

Fitting dial and hands

Fit dial by pressing simultaneously, with a leather buff in both dial feet. The dial is held by two dial fasteners.

Note:

- Endshake of hour wheel: 0.02 to 0.06 mm.

Colocación de la esfera y las agujas

Colocar la esfera apretando simultáneamente, con ayuda de un pulidor de piel, en el lugar de los 2 pies, los cuales están sujetos ahora en 2 sujetador de cuadrante.

Observación:

- Comprobar que el juego de la rueda de horas se encuentre entre 0,02 y 0,06 mm.

Posa del quadrante e delle lancette

Posare il quadrante premendo con un pezzo di pelle di camoscio simultaneamente dove si trovano i 2 piedini, essendo questi mantenuti da 2 ferma-quadrante.

Nota:

- Controllare il gioco della ruota delle ore, da 0,02 a 0,06 mm.

Note:

- Check the free play of the date indicator in the quick correction mode.
- Turn handsetting stem till the date indication jumps.
- Fit the hands at 12 PM (midnight). The press-in force used for fitting the hands may not exceed 30 N (~3,0 kp). We recommended the use of force compensated broaches (max. 3,0 kp).
- Use movement holder with central support for the jewel and having a hole for the centre pivot.
- Check the relative position of the hands.

Dial

To open the two dial fasteners, press in the direction of arrow A, so as to free the dial-foot hole. To close the bolts after the dial has been fitted, press in the direction of arrow B, as far as the case-fitting diameter of the main plate. To remove the dial, pull beak C towards D.

Observación:

- Comprobar la libertad del disco de fecha bajo la esfera en corrección rápida.
- Girar la tija de puesta en hora hasta el momento del salto de fecha.
- Colocar las agujas en medianoche. La presión de inserción no debe superar 30 N (~3,0 kp). Recomendamos utilizar husillos con fuerzas compensadas (3,0 kp como máx.).
- Utilizar un portapieza provisto de un apoyo central en la piedra con liberación para el pivote de segundero.
- Comprobar la marca de las agujas.

Esfera

Para abrir los dos fijadores de esfera, presionar en la dirección de la flecha A hasta que el orificio del pie de esfera esté libre. Para cerrar los cerrojos tras la colocación de la esfera, presionar en la dirección de la flecha B hasta el diámetro de encaje de la platina. Para extraer la esfera, tire del pico C en la dirección D.

Nota:

- Controllare che il disco del datario sotto il quadrante sia libero, in correzione rapida.
- Ruotare l'albero di messa all'ora fino allo scatto della data.
- Posare le lancette in corrispondenza della mezzanotte. La pressione di montaggio non deve essere superiore a 30 N (~ 3,0 kp). Si raccomanda l'uso di mandrini con forze graduate (3,0 kp max.).
- Utilizzare un portapezzo munito di un appoggio centrale sulla pietra con spostamento del perno dei secondi.
- Controllare il riferimento delle lancette.

Quadrante

Per aprire i due fissaggi del quadrante, premere nel verso della freccia A, fino a disimpegnare il piedino del quadrante. Per bloccare i fermi dopo la posa del quadrante, premere nel senso della freccia B, fino al diametro di incastro della platina. Per estrarre il quadrante, tirare il beccuccio C verso D.

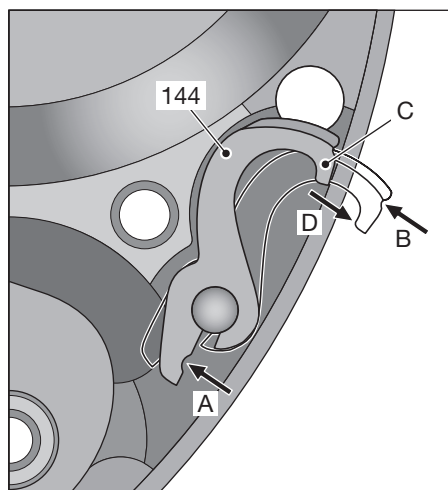

Ajustement aiguille des heures
Stundenzeigerpassung
Hour hand fitting

Ajustement aiguille des minutes
Minutenzeigerpassung
Minute hand fitting

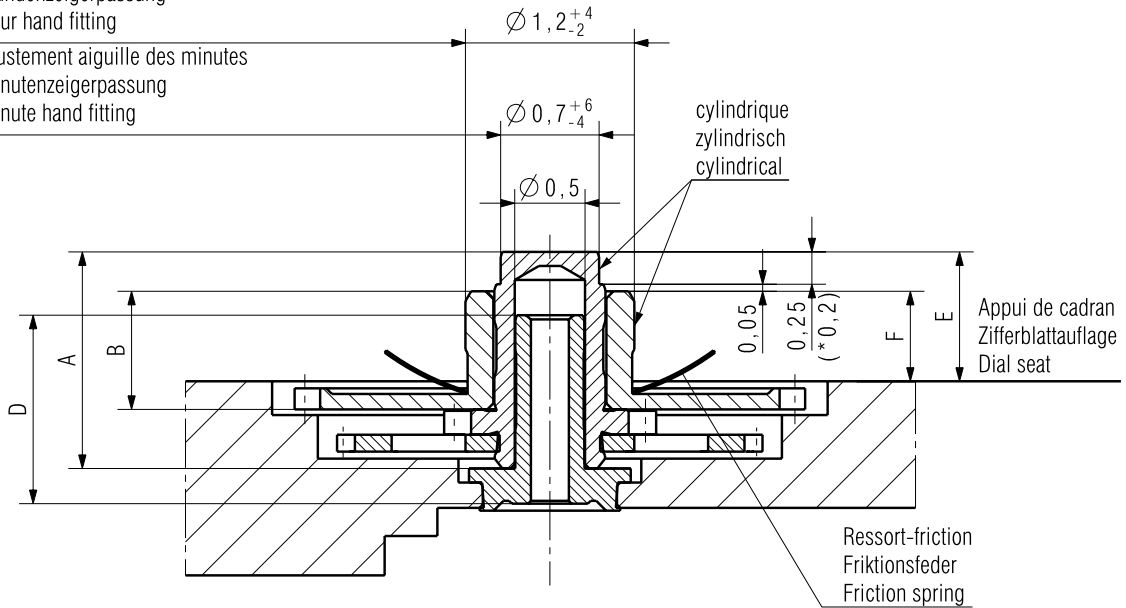

** Livraison contre supplément de prix
Lieferung gegen Aufpreis
Delivery with surcharge

Délais sur demande
Lieferfrist auf Anfrage
Delivery schedule on demand

Commercialisation sous réserve
Vertrieb mit Vorbehalt
Market launch with specific conditions

Aiguillage Zeigerwerkhöhe Hand fitting height	Longueur/Länge/Length			Dépassement Höhe über Zifferblattauflage Height over dial seat			Ep. cadran Zifferblattstärke Dial thickness	
	A	B	D	E	F			
réduit* niedrig* reduced* normal	1,51	0,84	1,34	0,9	0,65		0,3	
1	1,76	1,04	1,34	1,15	0,85		0,4	
2**	2,01	1,29	1,34	1,4	1,1		0,4 - 0,7	
3**	2,26	1,54	1,34	1,65	1,35		0,4 - 0,95	
Aiguilles Zeiger Hands					Aiguille d'heure Stundenzeiger Hour hand	Aiguille de minute Minutenzeiger Minute hand		
Masse/Masse/Mass					max.	mg	10	
Balourd/Unwucht/Unbalance					max.	µNm	3	
Kaliber / Calibre / Caliber 256.031 / 256.041					Masstab Echelle Scale --		CATIA V5 Masse in mm Dimensions en mm Dimensions in mm Tol. 1/1000 mm	
AIGUILLAGES ZEIGERWERKHÖHEN HAND FITTING HEIGHTS					Z0091683	Version 01	Revision 00	Blatt Feuille Sheet 01/01
 ETA SA MANUFACTURE HORLOGÈRE SUISSE DEPUIS 1793 A COMPANY OF THE SWATCH GROUP			Ersatz für/En remplacement de/Remplacement for Aenderung/Modification 22226		Klass. ZVACC Erstellt Etabli Created 19.04.2007 SCA		Geprüft Contrôlé Controlled 19.04.2007 CHI	Freigegeben Libéré Released 20.04.2007 FEU

We reserve all rights for this document. It is meant for the recipient only and it may not be copied, printed or given to a third person without our written permission. Quedan reservados todos los derechos relacionados con este documento, que está dirigido únicamente al destinatario. Queda por lo tanto prohibida su copia, impresión o cualquier otra autorización por escrito. Ogni diritto su questo documento è riservato. Il documento è indirizzato esclusivamente al destinatario e non può essere copiato, stampato o ceduto a terzi senza un'autorizzazione scritta.

This page has deliberately been left blank in case of A3 format printing.

Esta página se han dejado en blanco a propósito en caso de imprimirla en formato A3.

Questa pagina è lasciata intenzionalmente bianca in caso di stampa formato A3.

This page has deliberately been left blank in case of A3 format printing.

Esta página se han dejado en blanco a propósito en caso de imprimirla en formato A3.

Questa pagina è lasciata intenzionalmente bianca in caso di stampa formato A3.

Modifications compared with previous document versions**Modificaciones comparadas con las versiones anteriores del documento****Modifiche comparate con le versioni precedenti del documento**

Version Versión Versione	Date Fecha Data	Modification	Modificación	Modifica	Page Página Pagina
03	17.06.2009	New layout	Nuevo layout	Nuova layout	1-8
		Allocation per caliber	Asignación por calibres	Ripartizione per calibri	--

All modifications reserved.

Salvo modificación.

Con riserva di ogni eventuale modifica.

This document can be found on the Customer Service Portal (CSP):

www.eta.ch

- Customer Service
- Customer Service Portal
- Technical Documents

Este documento se encuentran en el Customer Service Portal (CSP):

www.eta.ch

- Customer Service
- Customer Service Portal
- Technical Documents

Il presente documento si trovano sul Customer Service Portal (CSP):

www.eta.ch

- Customer Service
- Customer Service Portal
- Technical Documents



ETA^{SA}
MANUFACTURE HORLOGÈRE SUISSE
DEPUIS 1793

CUSTOMER SERVICE

Bahnhofstrasse 9
P.O. Box 359
2540 Grenchen
Switzerland

Phone +41 (0)32 655 27 77
Fax +41 (0)32 655 84 30

etacs@eta.ch
www.eta.ch